

TWIN FORKS

Wireless weighing forks for forklift

OPERATING INSTRUCTIONS

ENGLISH

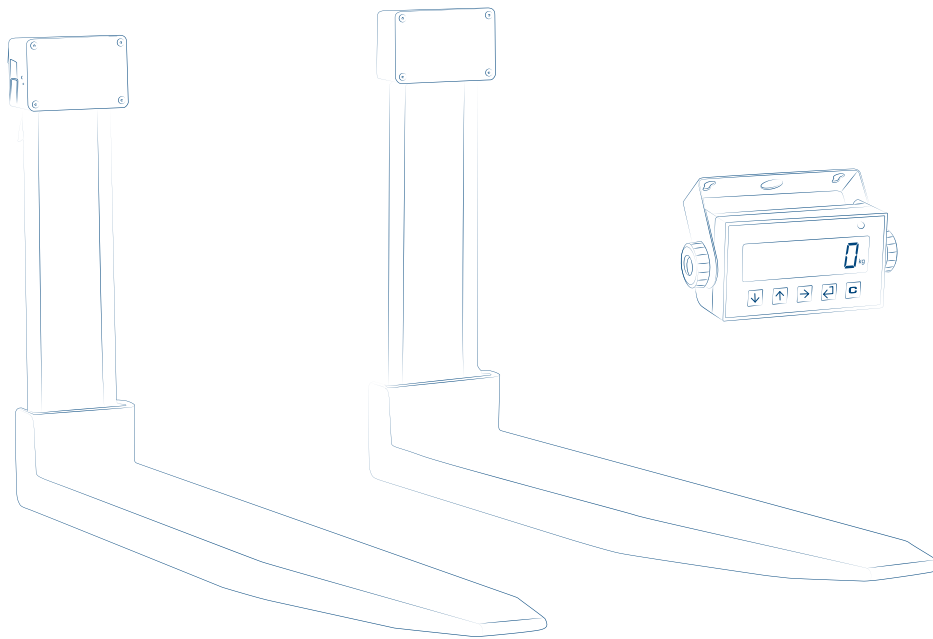

Introduction	5
Warnings and installation	5
System parts	5
Display and keyboard	6
Charging the batteries	8
Energy saving	8
System description	9
Correct use of the system	9
Basic functions	10
Switching on	10
Switching off	11
Zero	11
Adjusting the display brightness	11
Automatic tare	12
Clearing the tare	12
Setting a known tare value (PT)	13
Print	14
Metric information	14
Advanced functions of the scale	15
How to enter the functions menu	15
Horizontal weight totalisation	16
Weight control	18
Exchange between net weight and gross weight	22
Unit of measure conversion	23
Replacing the printer roll	25

Continued on the next page...

Configuration menu

26

<i>CLoCk</i> - DATE AND TIME	26
<i>ELt .Shh</i> - Fork switch-on SENSITIVITY	26
<i>SiL .t n</i> - ENERGY SAVING ADJUSTMENT	27
<i>dS .t n</i> - FORK AUTO SWITCH-OFF	27
<i>PrEC . 10</i> - HIGH RESOLUTION READING DIVISION	27
<i>SErEE n</i> - ADJUSTING THE DISPLAY	28
<i>tArE</i> - TARE	29
<i>AutoFF</i> - AUTOMATIC SWITCH-OFF	29
<i>t n .rES</i> - TICKET NUMBER RESET	29
<i>rESEt</i> - FACTORY CONFIGURATION RESET	30
<i>d iAG</i> - DIAGNOSTICS	30

Error messages

31

Notes

32

Introduction

Dear Customer,
Thank you for purchasing a DINI ARGEO product.

This manual explains the usage of the weighing system with forks for forklifts.
In particular, zero, tare and all the weighing electronic functions are described to assist the forklift driver during use.

For any additional information or specific requests, please contact your local dealer.
This publication is optimised for A4 printing.

Warnings and installation

- The weighing system does not change the safety regulations normally applied to the forklift.
- Before weighing, make sure that the forklift is stationary, on a flat surface and that there are no people in the area around the load.
- The employee training on the use of the system is the purchaser's responsibility.
- Please read this manual carefully before using the system.
- Assistance must only be carried out by personnel authorised by Dini Argeo.
- Dini Argeo is not responsible for any weighing errors resulting from improper use of the system.



WARNING



Installation must be carried out by specialised technical personnel. Follow the instructions in the technical manual carefully.

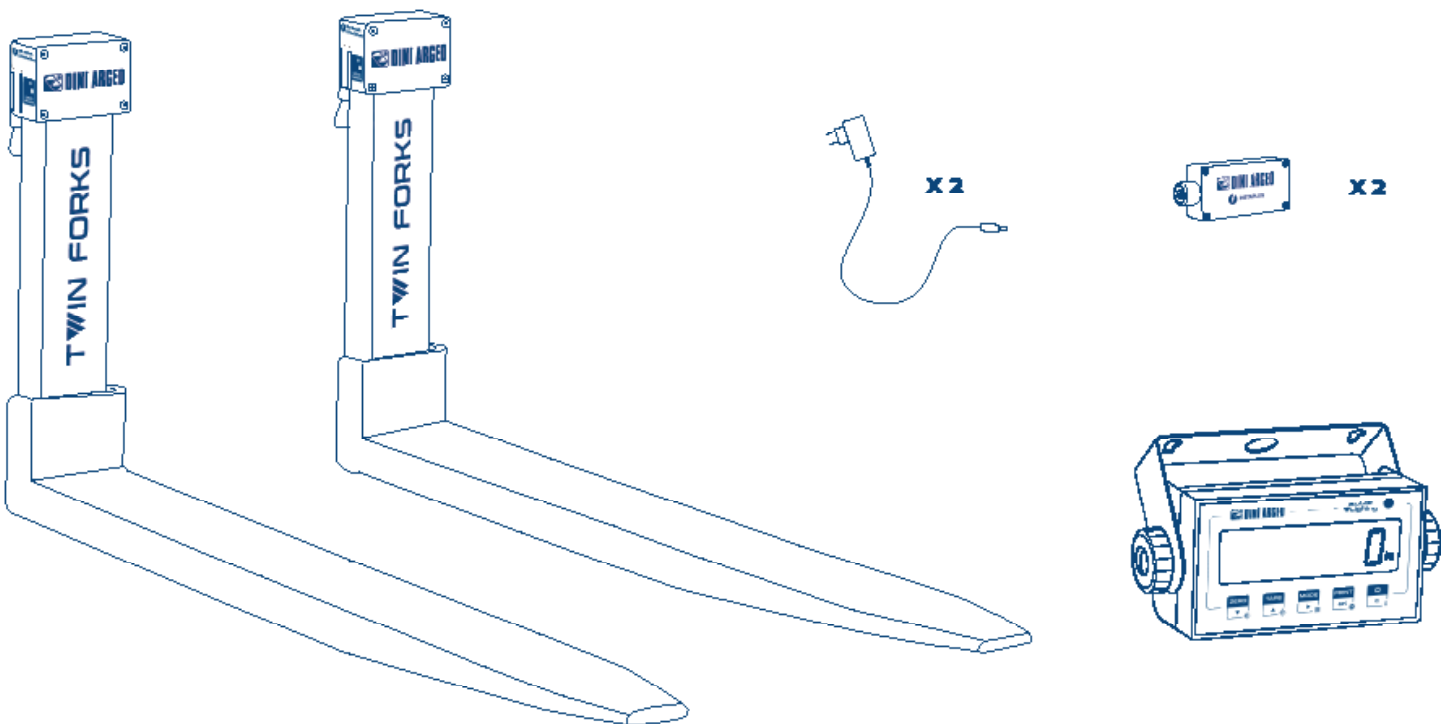

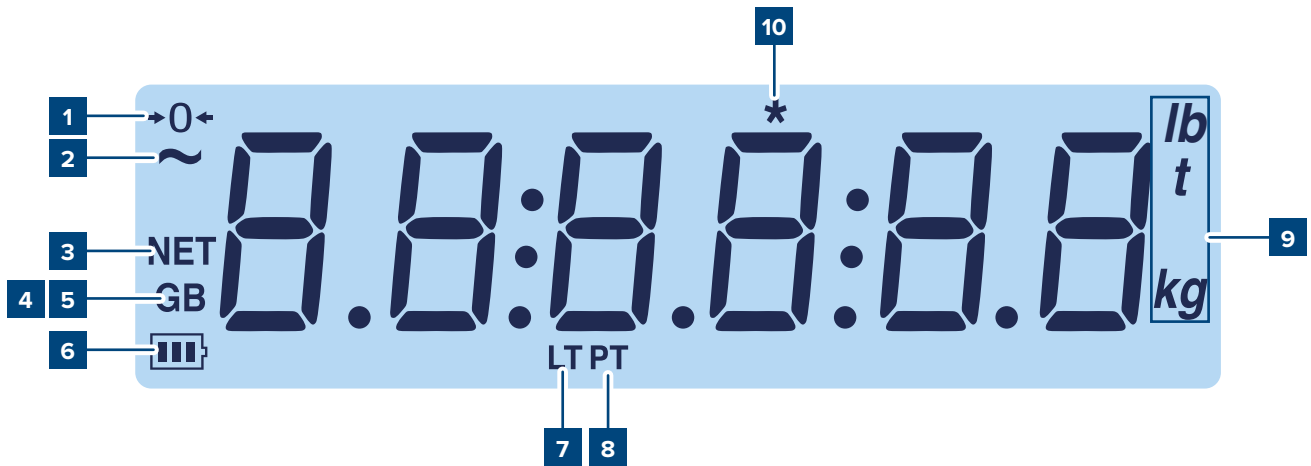

System parts



Display and keyboard



ITEM	ICON	DESCRIPTION
1	→0←	This indicates that the scale is empty (gross zero).
2	~	This indicates that the weight is unstable.
3	NET	The net weight is displayed. Note: A tare has been stored.
4 / 5	G B	The gross weight is displayed.
6		This indicates the charge level of the fork batteries: 
7	LT	A tare has been blocked.
8	PT	A manual tare is active.
9	<i>lb ... kg</i>	This indicates the unit of measure: pounds (lb), tons (t), kilograms (kg), grams (g).
10	*	This indicates that a key has been pressed. In some operating modes, this indicates that a specific function is active.

Key	Description
	<ul style="list-style-type: none"> Resets the weight value on the scale. If pressed for a long time (2 sec), it allows you to set the brightness of the display.
	<ul style="list-style-type: none"> Performs tare on the scale. If pressed for a long time (2 sec) it allows you to insert a preset tare.
	<ul style="list-style-type: none"> Recalls the function specific to the operating mode. If pressed for a long time (5 sec) it allows you to change the operating mode.
	<ul style="list-style-type: none"> Confirm key. Print the receipt. If pressed for a long time (5 sec) it allows you to enter the configuration menu.
	<ul style="list-style-type: none"> If pressed for 2 seconds, it turns off the instrument. If pressed for 5 sec it shows the metrological information.



WARNING

For a clearer view and advanced key and mode functions, see the chapter “BASIC FUNCTIONS” and “ADVANCED FUNCTIONS”.

Charging the batteries

The weight indicator shows the battery charge level through the icon "▢▢▢" in real time.

The batteries must be recharged when the weight indicator shows the lowest charge level (symbol ▢). Charging time is approximately 5 hours.

The message "L O B . b A t" indicates that the forks are completely flat and will automatically switch off within 5 seconds.

Procedure for removing the battery from the fork:

1. Remove the battery tray by pulling it out of the lower bracket.
2. Remove the battery.
3. Reinsert the empty drawer into the fork.

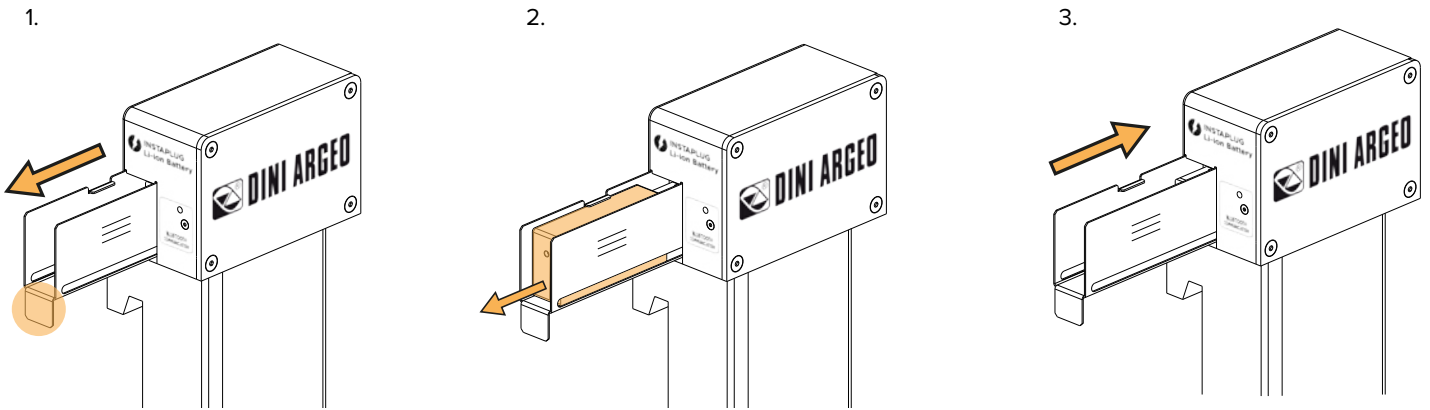

Connect the supplied power supply to the power socket and insert the plug into the battery connector.

The LED on the power supply unit lights up and turns red while charging.

Leave the battery to charge until the LED turns green.

Charging time varies according to the remaining charge level. Contact your dealer if the charging operation is not completed after 6 hours.



WARNING

Use only original Dini Argeo batteries and power supplies.

Energy saving

The board inside the weighing forks is designed to save energy. Therefore various energy saving systems are activated when the system is not used, i.e. there is no movement and no weight variation:

- The forks switch to partial power saving mode after 2 seconds of idleness.
- The indicator in the cab and the forks switch off after 5 minutes of idleness with zero weight.
- The forks switch to sleep mode, from which it is possible to exit by moving the forks, after 20 minutes of idleness in any condition (either with no weight or with load).

System description

The TWIN FORKS weighing system for forklifts consists of 2 digital forks and an indicator in the cab. There are two load cells in each fork and a board for communicating data to the indicator in the cab via Bluetooth. Each fork is also equipped with a digital accelerometer for tilt control and automatic on / off function based on movement.



WARNING

Installation must be carried out by specialised technical personnel. Follow the instructions in the technical manual carefully.

Correct use of the system

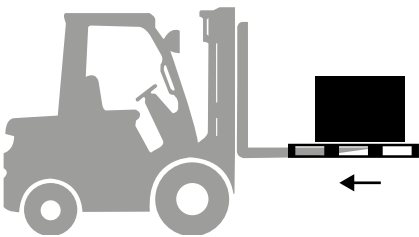

The system was designed for weighing loads on Euro pallets. For best performance make sure that the load is always well distributed and that its centre of gravity is as close as possible to the centre of the forks.

The weighing operation must be carried out with the forklift stationary and the forks stopped.

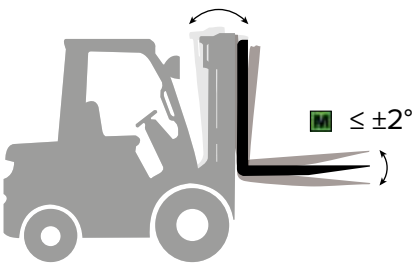

Take the weight reading when the forks are in the horizontal position.

On approved models, weighing is only permitted if the tilt of the forks is within $\pm 2^\circ$.

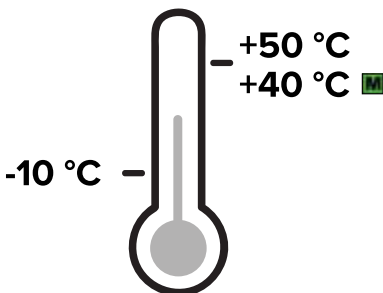

The operating temperature range of the system is $-10 / +50^\circ\text{C}$ ($-10 / +40^\circ\text{C}$ for approved systems).

Using the system outside of this range can result in a significant decrease in accuracy as well as irreversible damage to the batteries.

Failure to do so will also result in voiding the warranty conditions.

Switching on

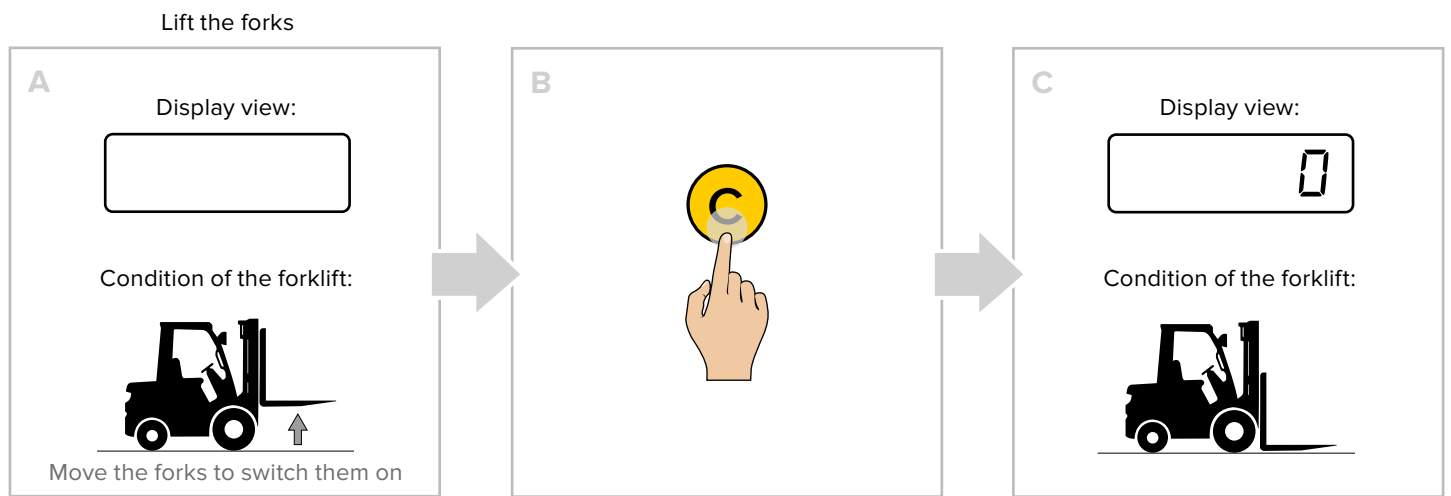

The switch-on and coupling cycle can take up to 6 seconds.

Switching off

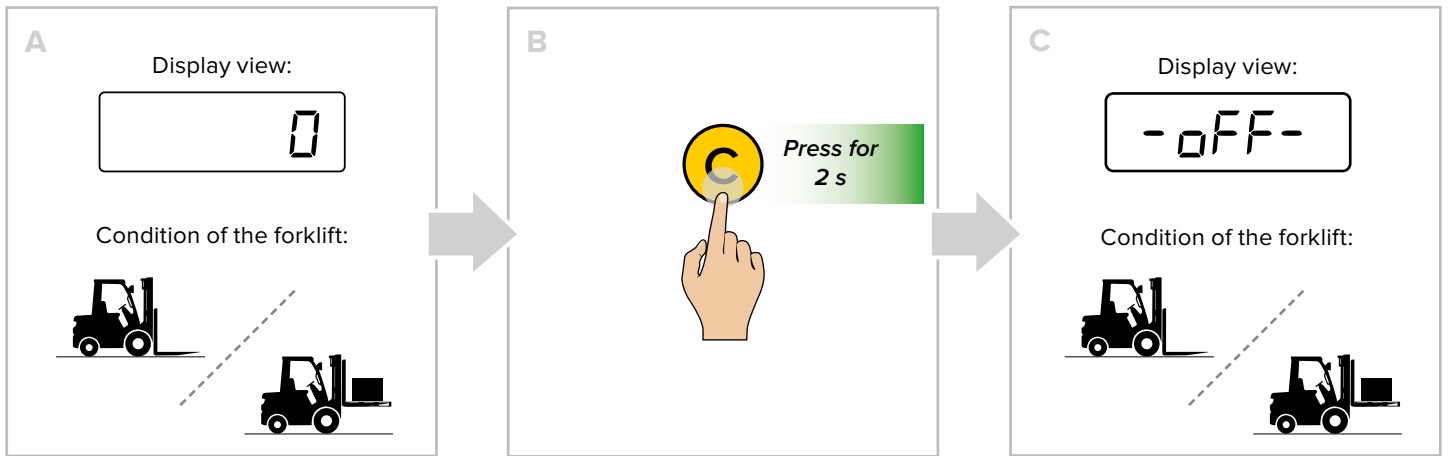

i The forks automatically switch to energy saving mode after turning off the indicator.

Zero

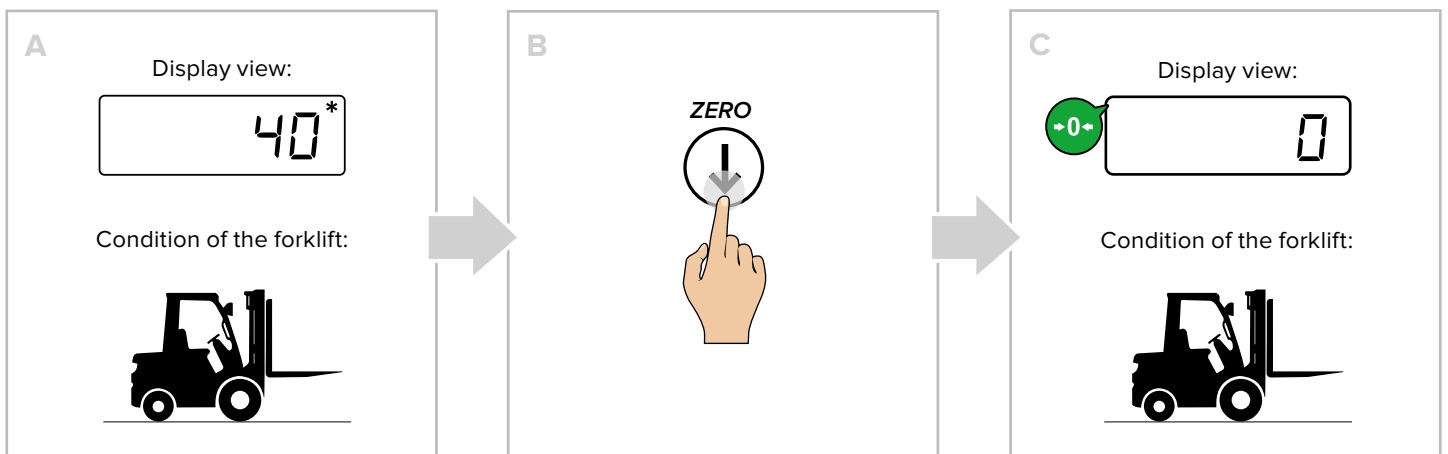

(*) The weight value can be reset on the forks up to 2% of the maximum capacity.

Adjusting the display brightness

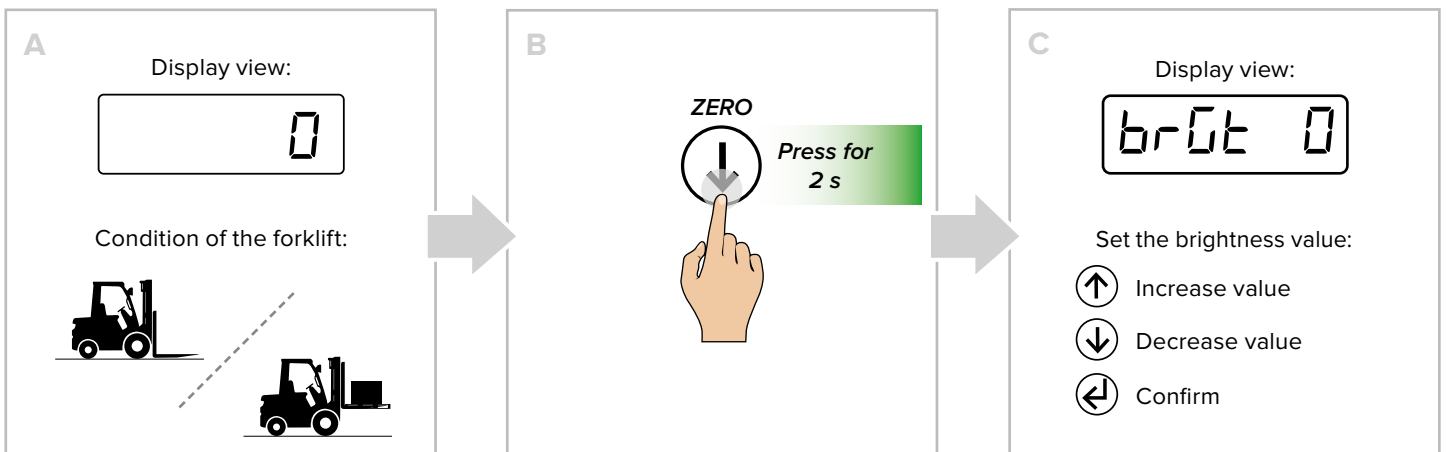

Automatic tare

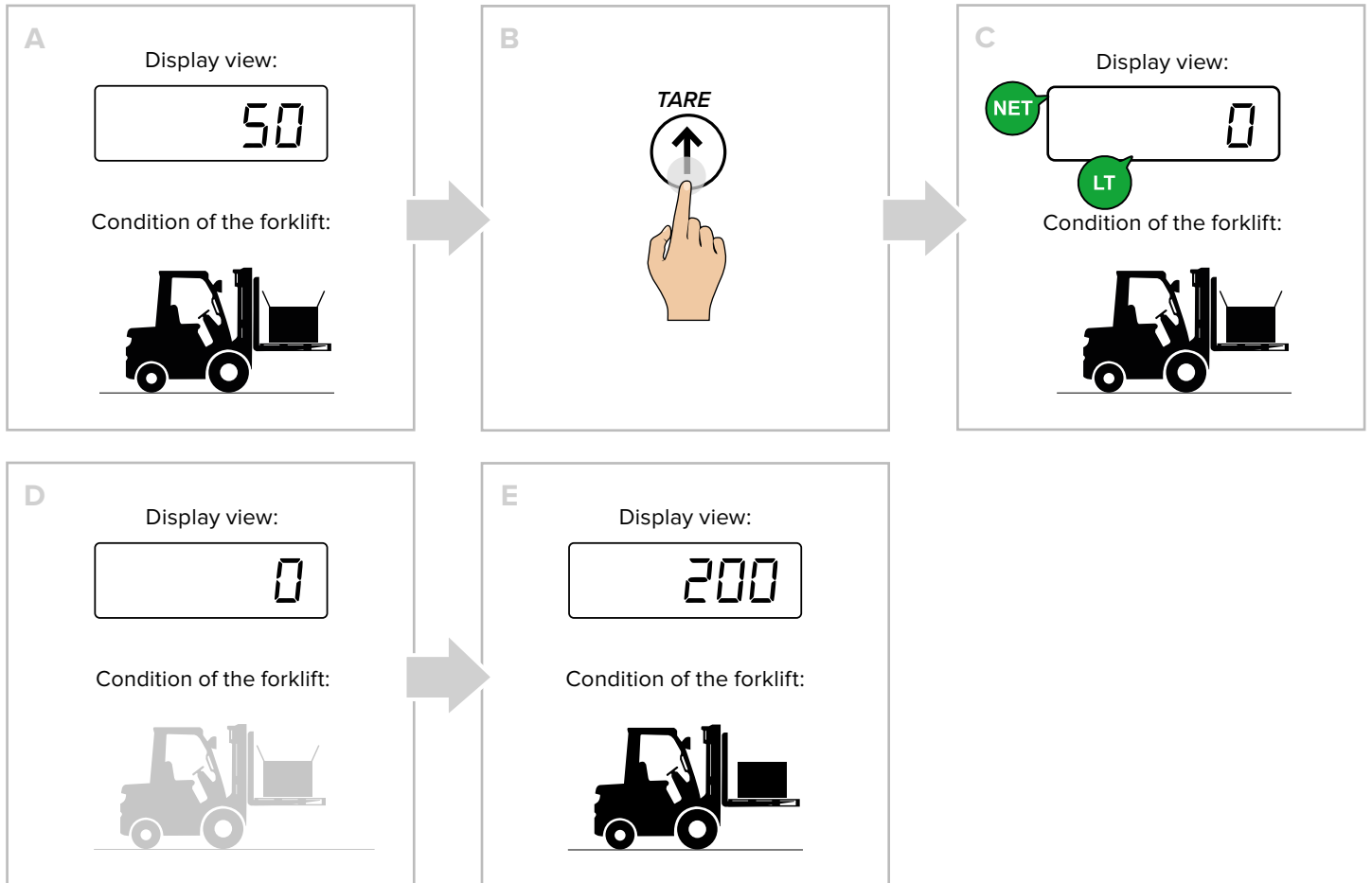

Clearing the tare

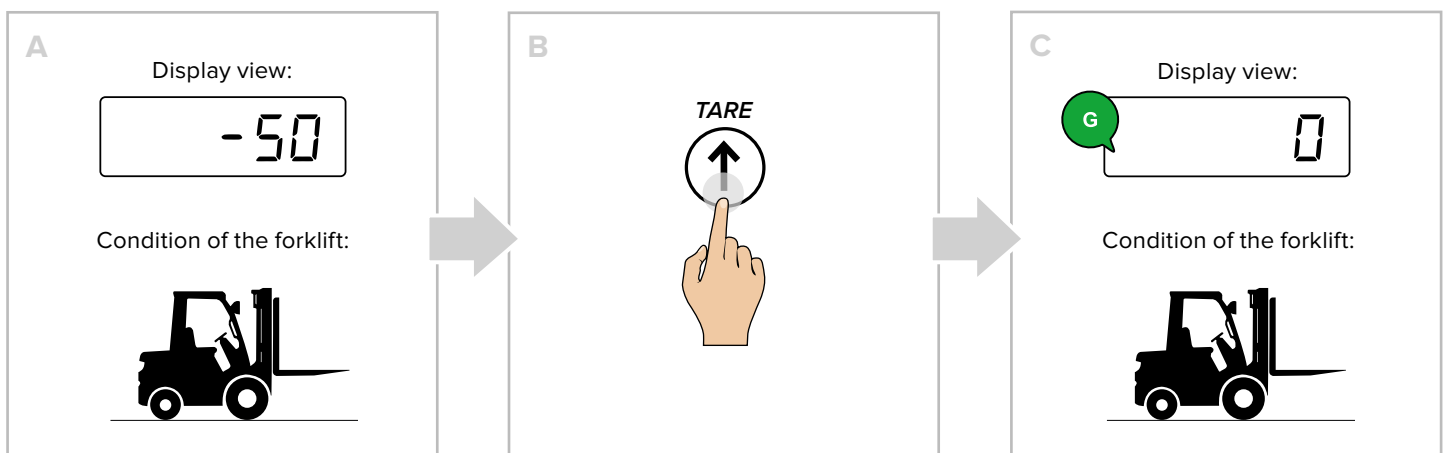

Setting a known tare value (PT)

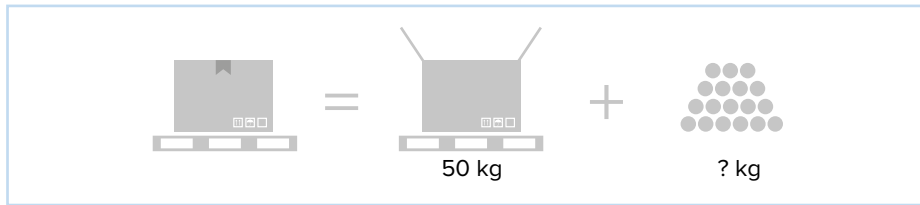

A

Display view:

Condition of the forklift:

B

TARE

Press for 2 s

C

Display view:

Setting the tare value:

Increase / decrease the value

D

CONFIRM

E

Display view:

Condition of the forklift:

F

Display view:

Condition of the forklift:

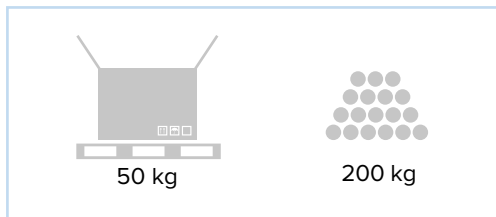

Print

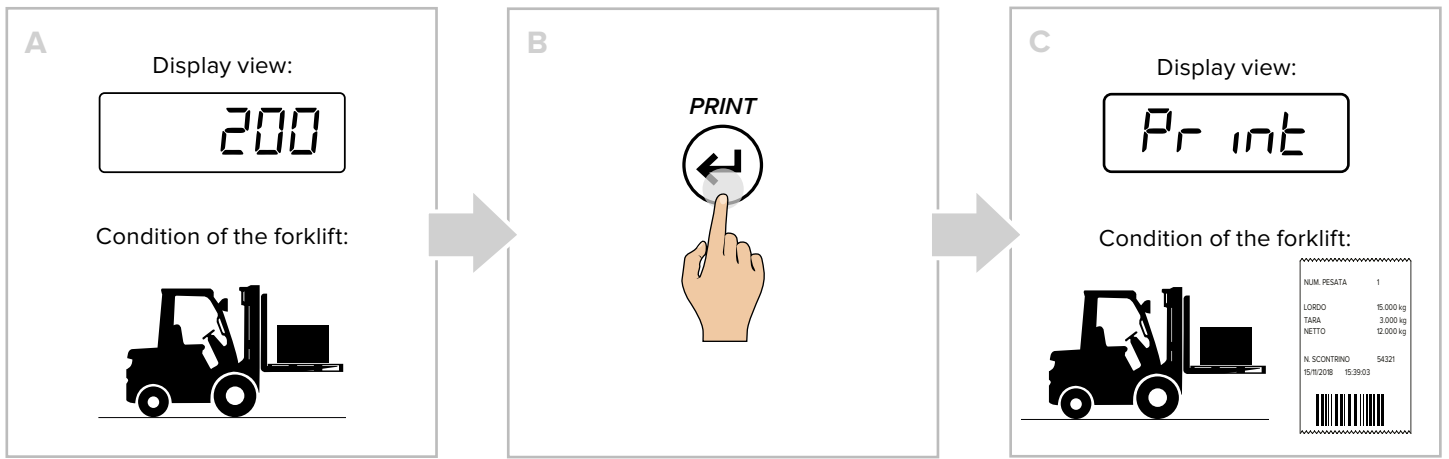

Metric information

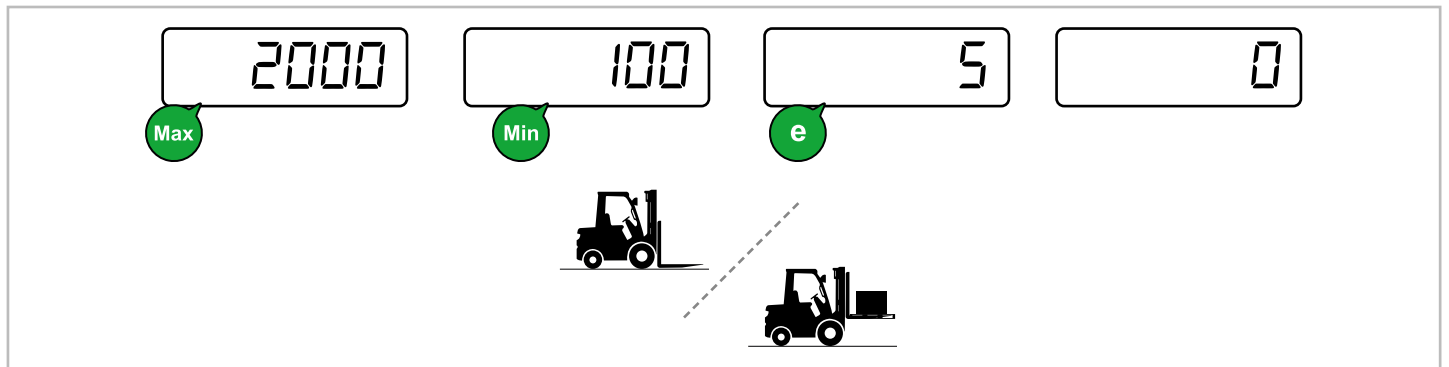
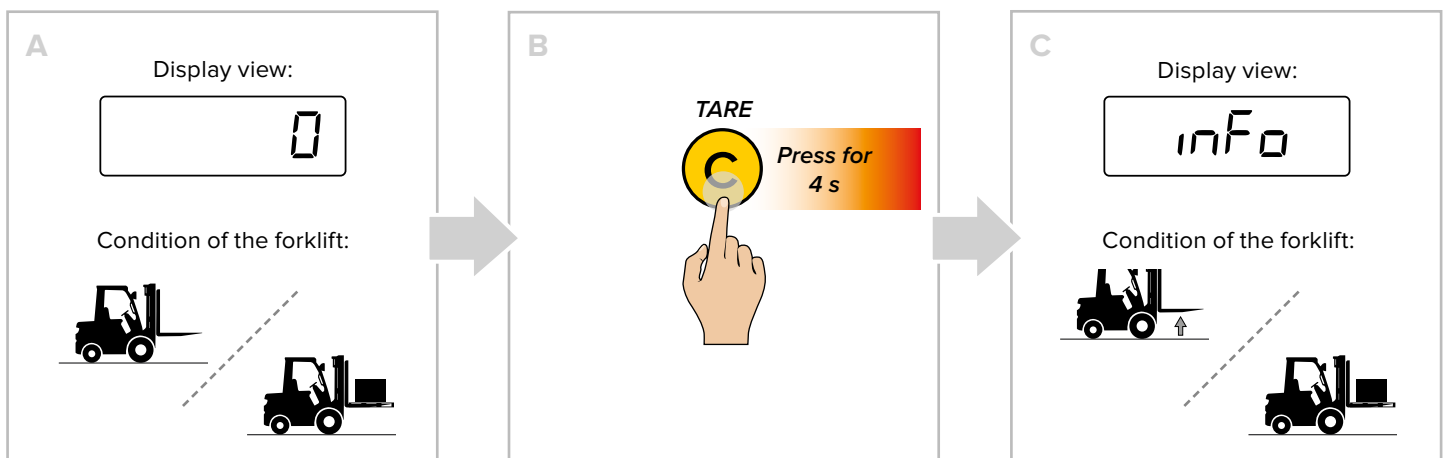

How to enter the functions menu

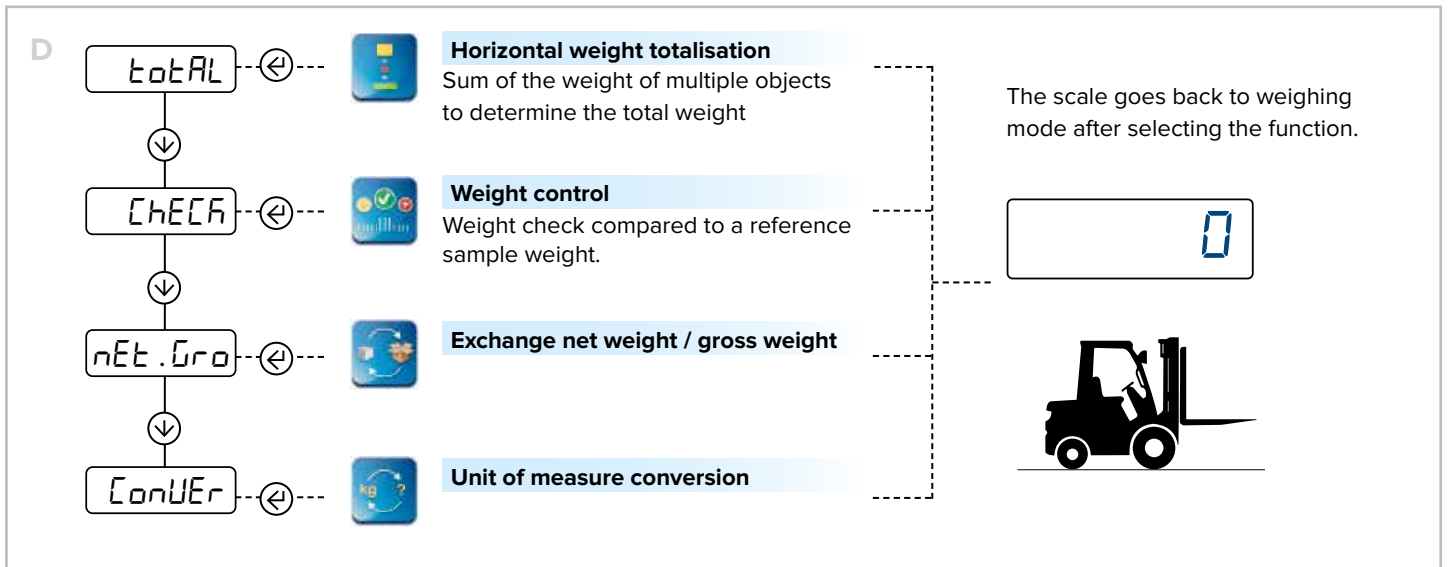
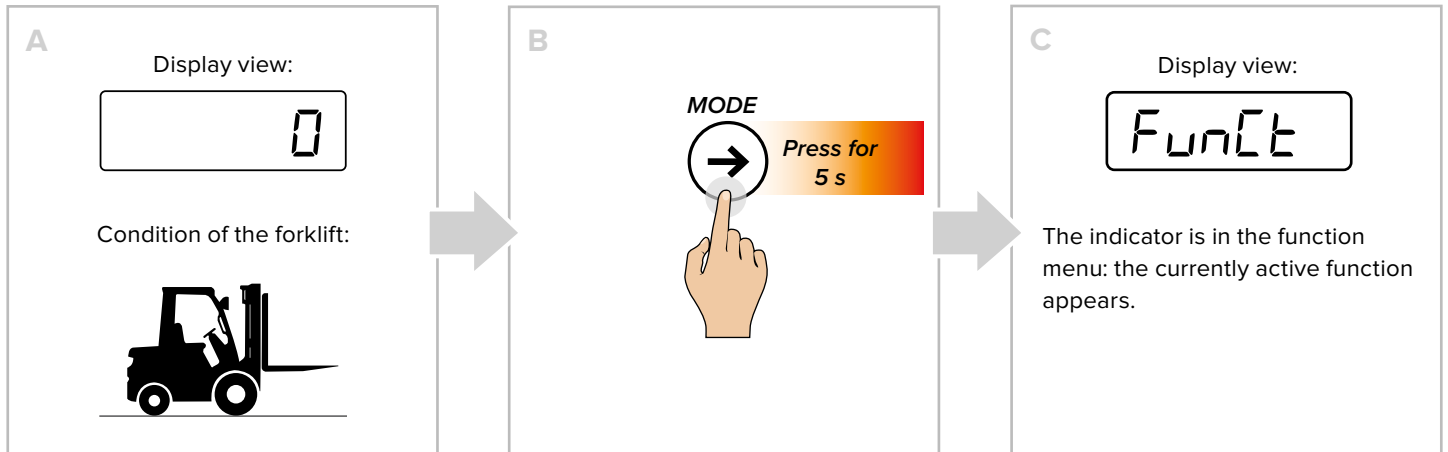

Horizontal weight totalisation

HOW TO SUM THE WEIGHS

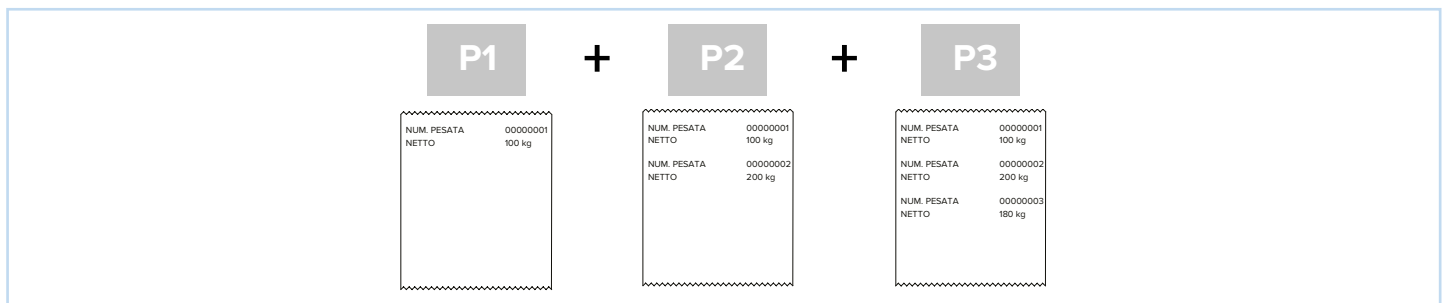
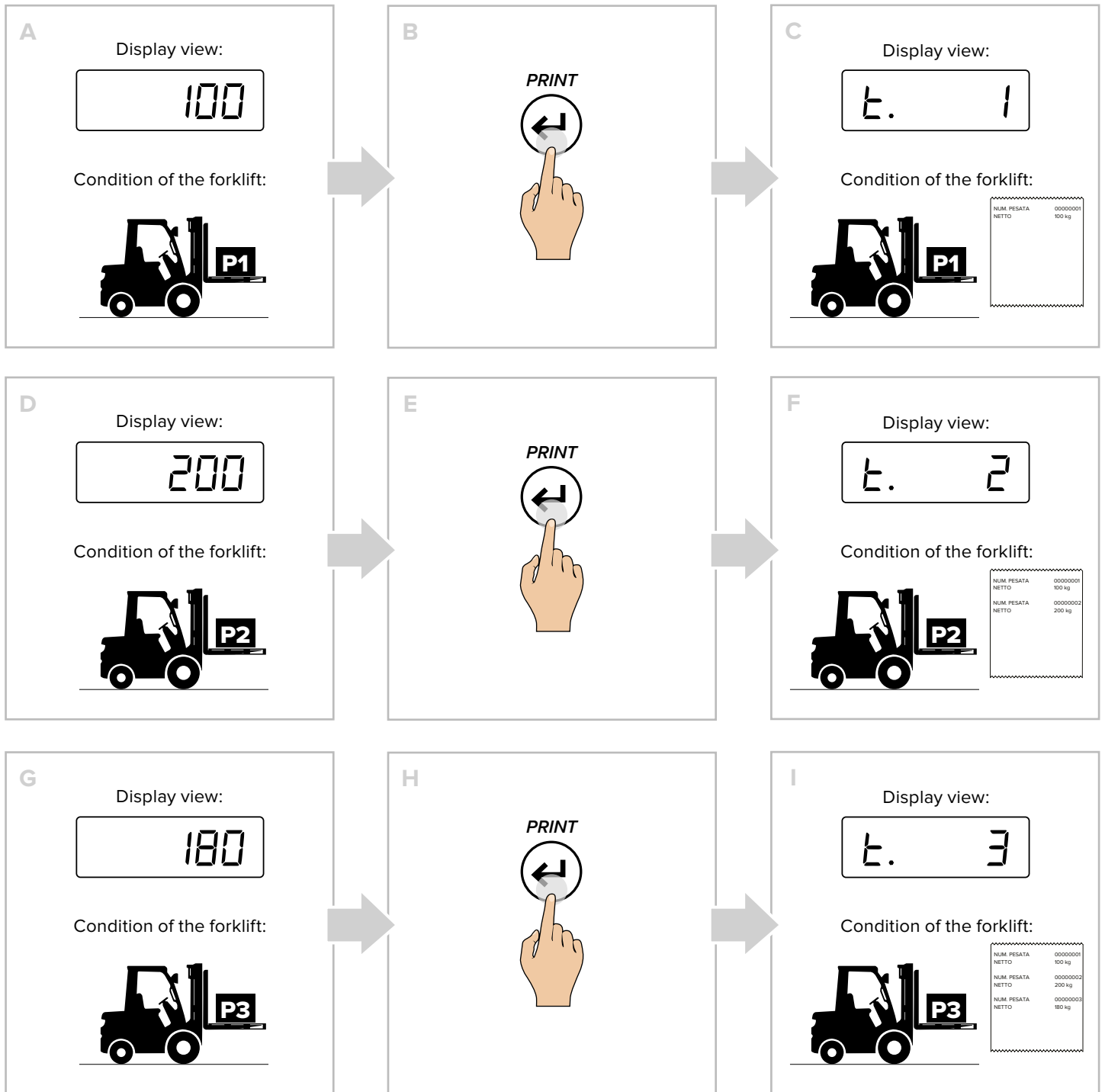

HOW TO MOMENTARILY READ THE TOTAL

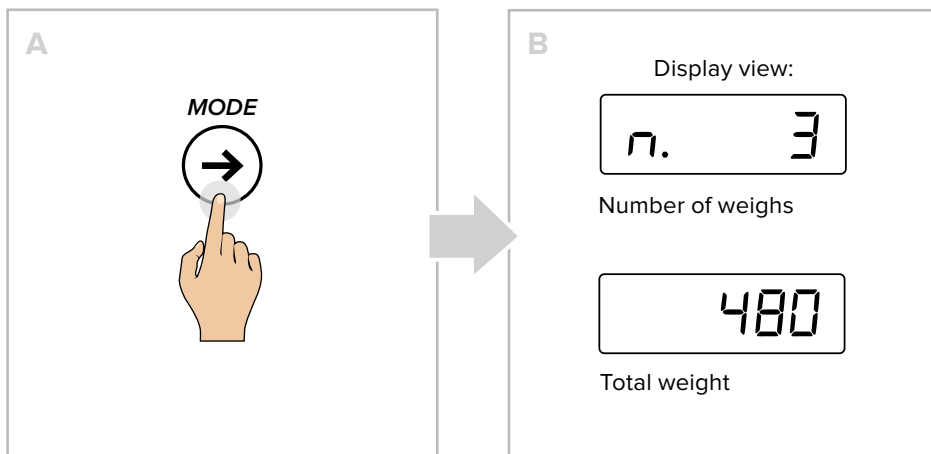

HOW TO END WEIGHT TOTALISATION AND RESET THE TOTAL

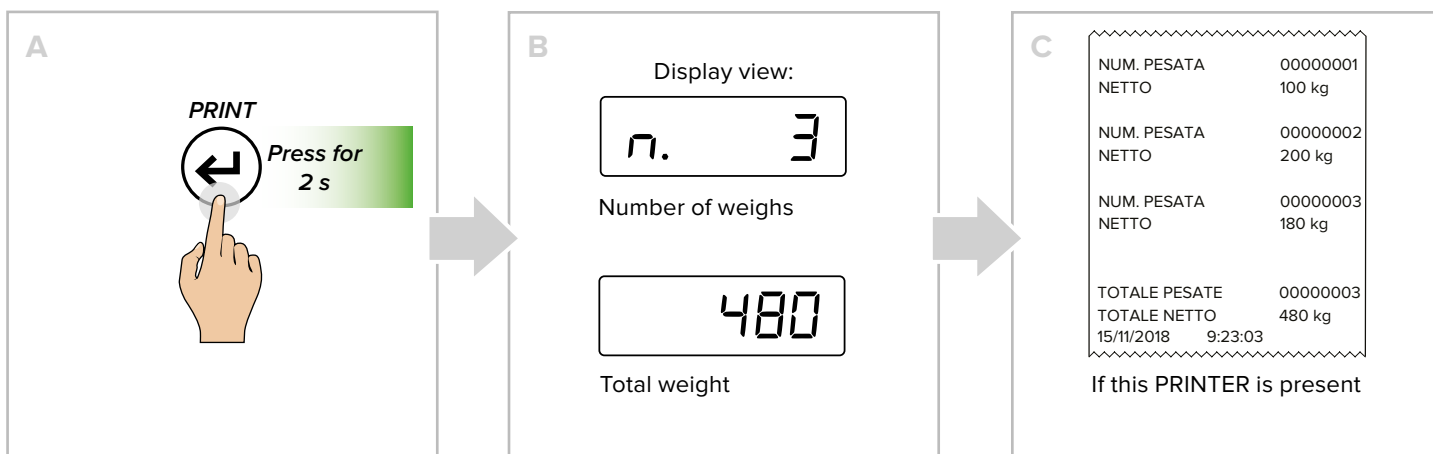

HOW TO PRINT AND RESET THE GRAND TOTAL

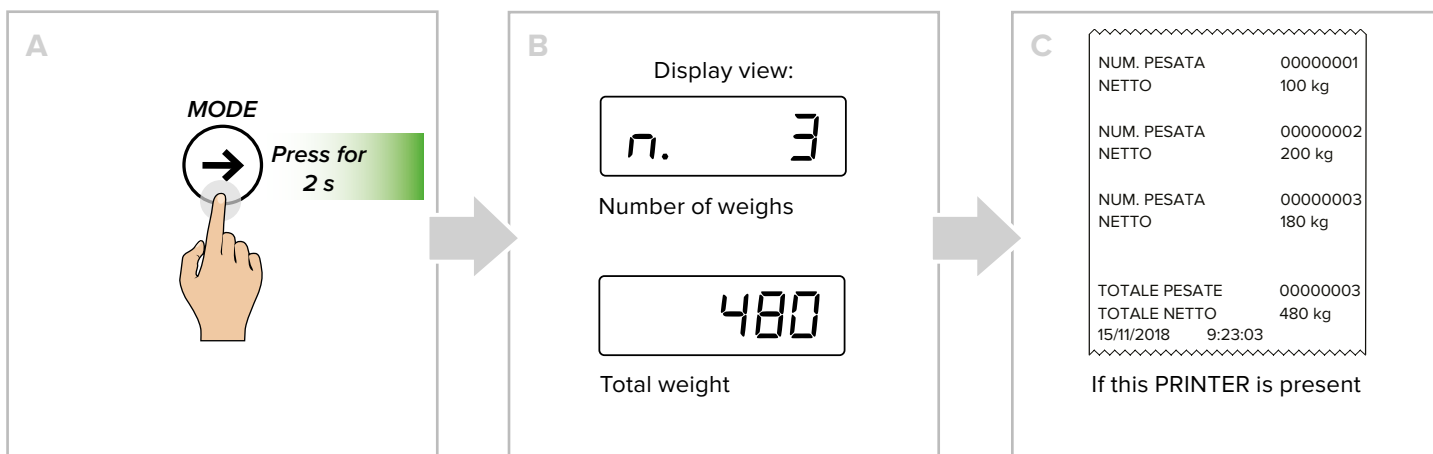

Weight control

HOW TO START THE CHECK WITH KNOWN REFERENCE WEIGHT

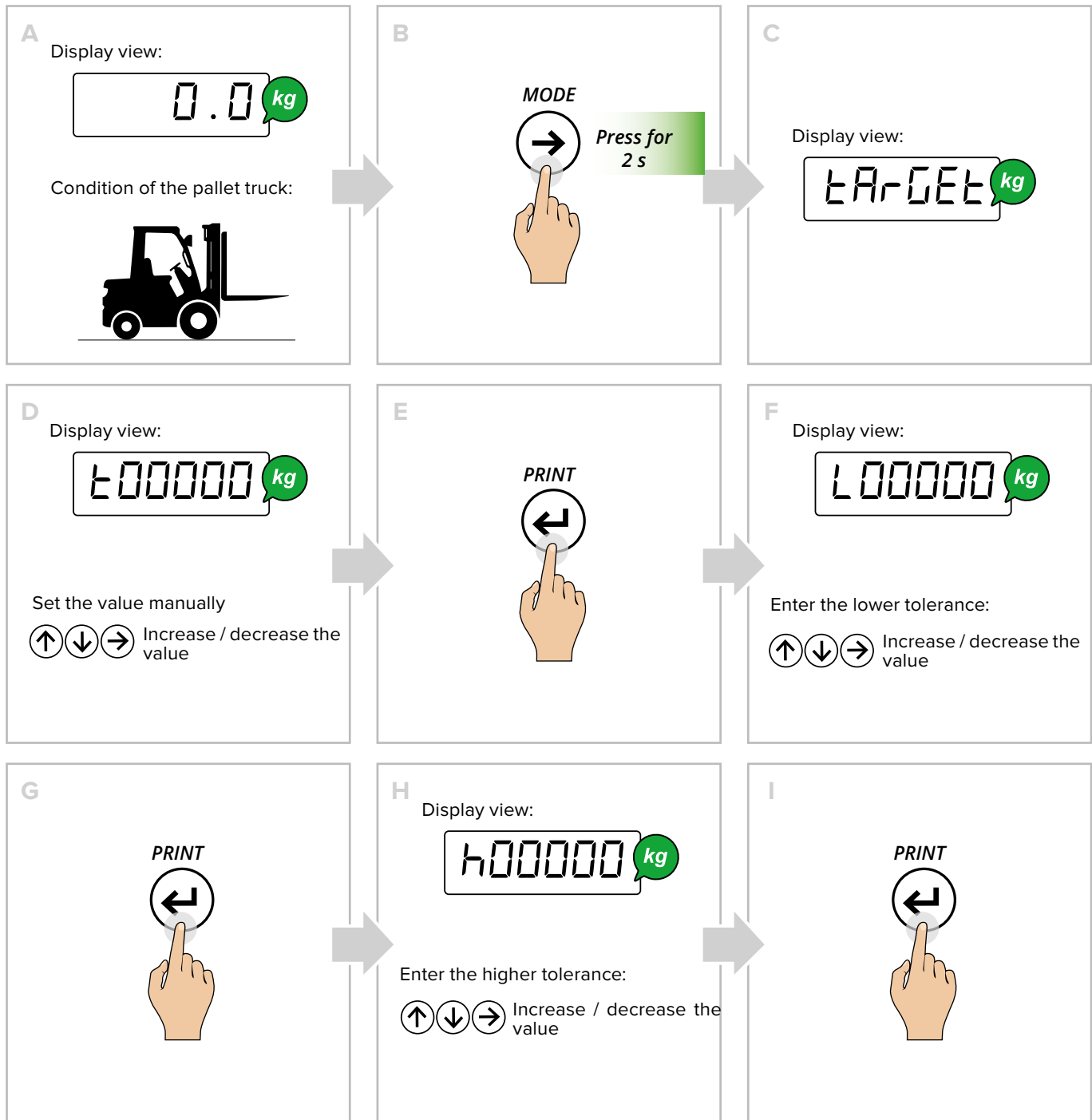

Example 1:

To check a weight of 1000 g with +/- 5 g tolerance (that is, between 995 g and 1005 g), set:

t0 1000
L00005
h00005

Example 2:

To check a weight of 500 g with + 10 g / - 20 g tolerance (that is, between 480 g and 510 g), set:

t00500
L00020
h00010

HOW TO START THE CHECK WITH AUTOMATIC TARGET ACQUISITION

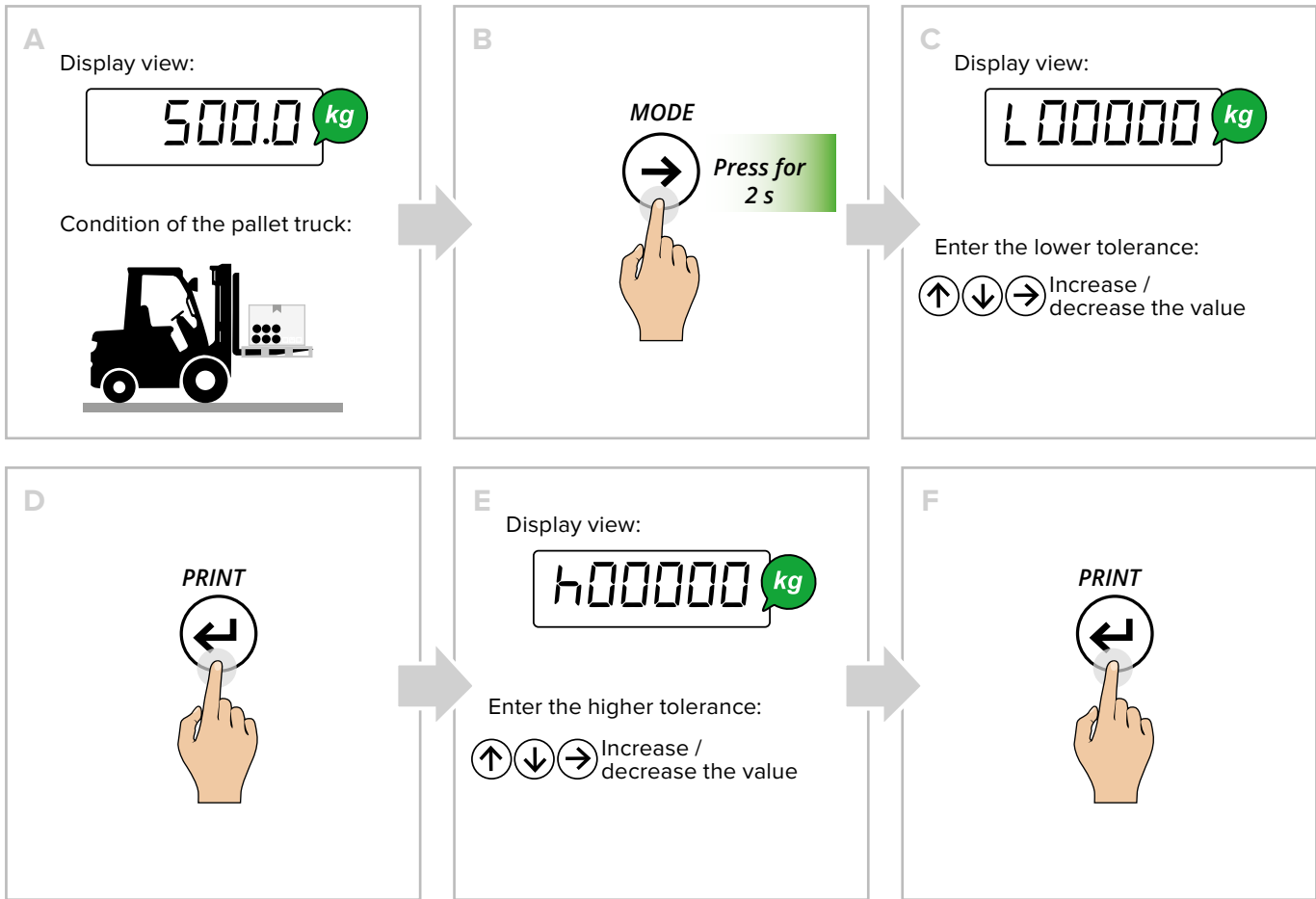

HOW TO CHECK THE WEIGHT

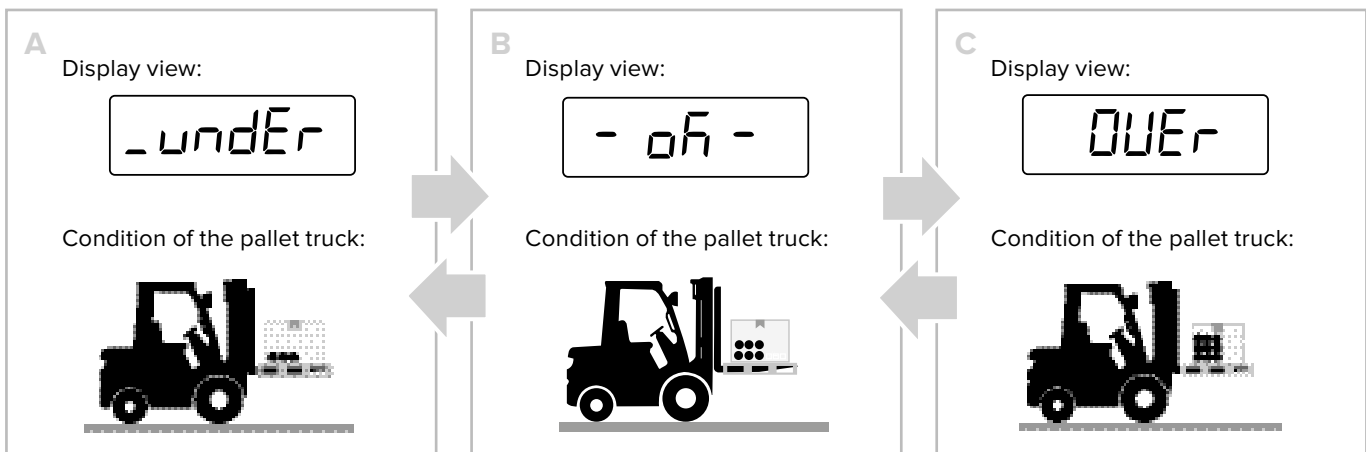

HOW TO UPDATE THE NOMINAL WEIGHT WITH KNOWN REFERENCE WEIGHT

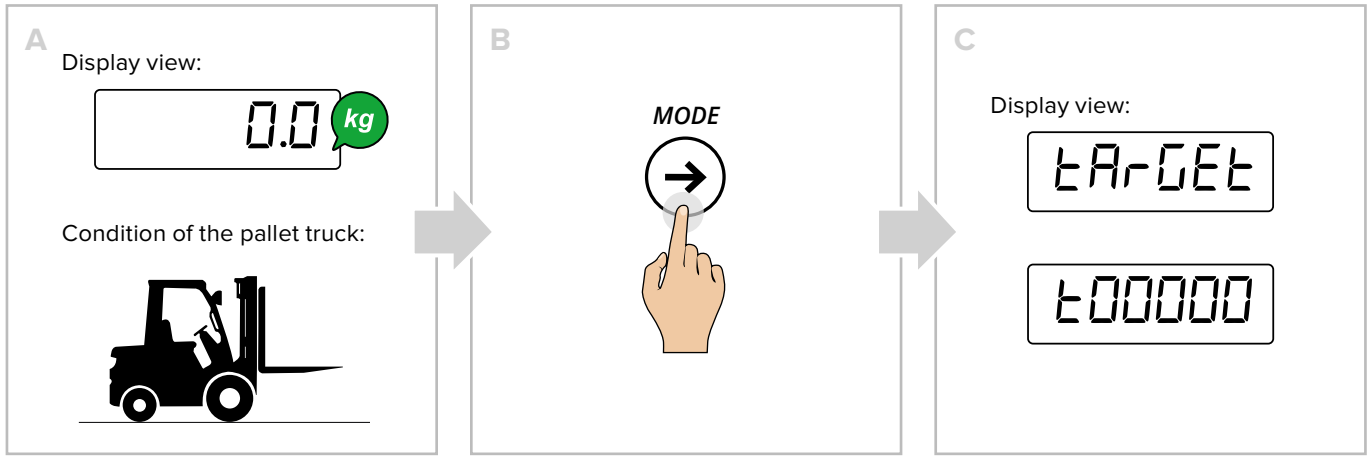

HOW TO UPDATE THE NOMINAL WEIGHT WITH AUTOMATIC TARGET ACQUISITION

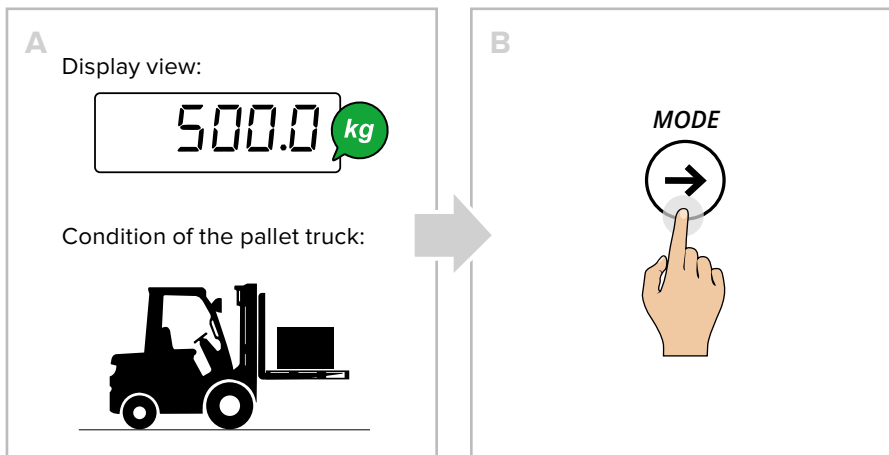

HOW TO EDIT THE CHECK THRESHOLDS

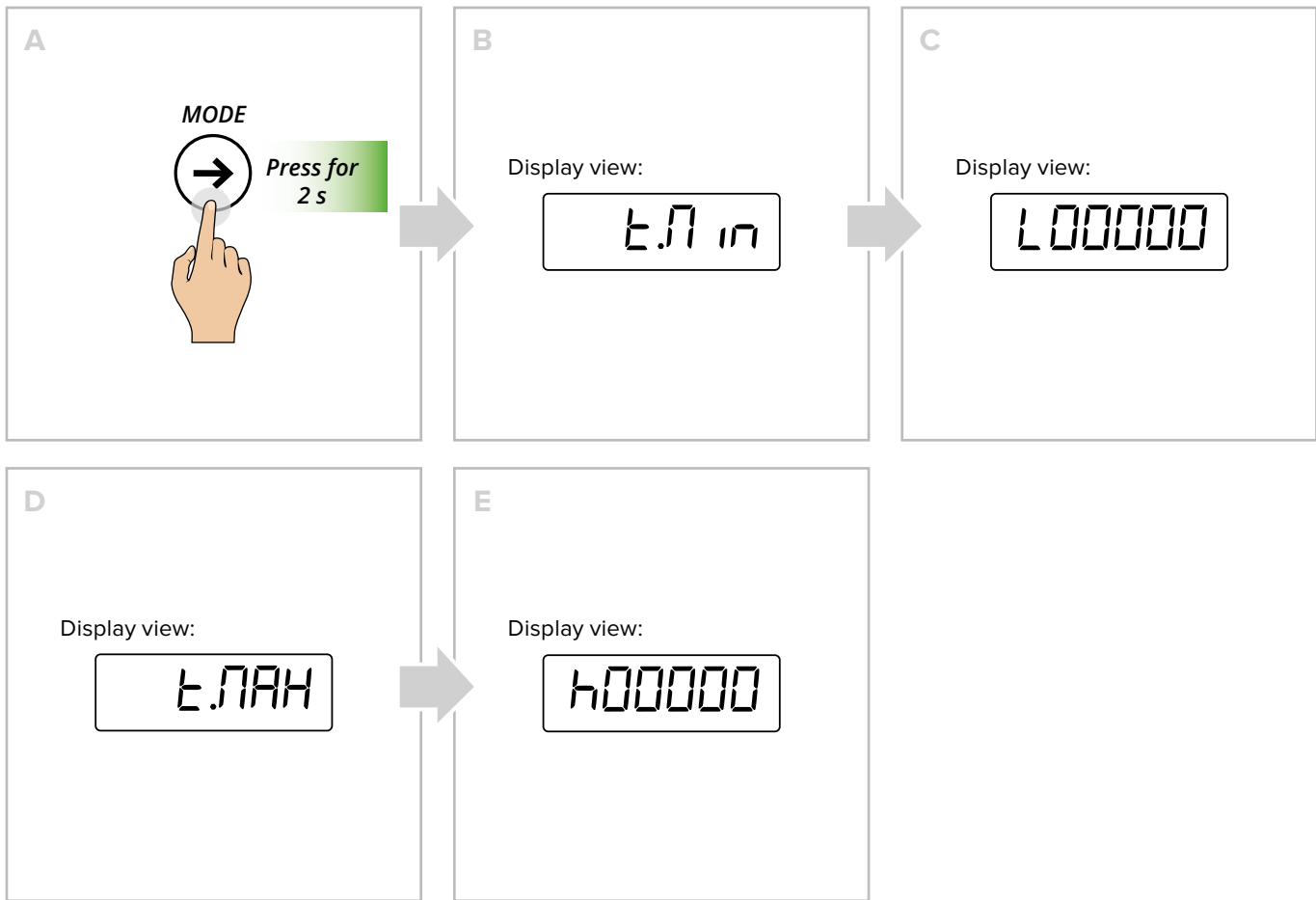

Exchange between net weight and gross weight

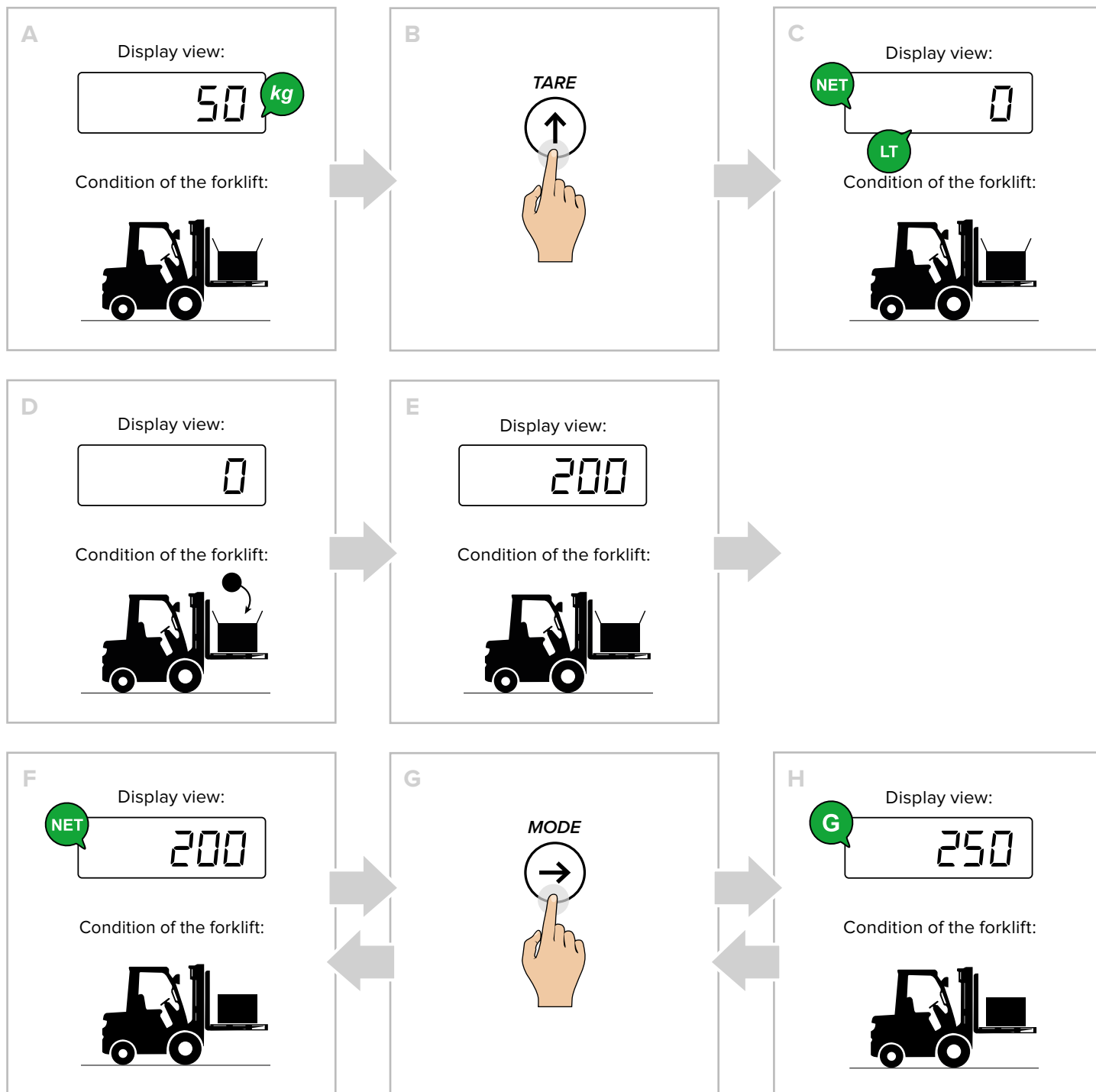

By pressing  at any time, you can change from net to gross weight.

Unit of measure conversion

HOW TO CONVERT THE UNIT OF MEASUREMENT TO POUNDS (STANDARD MODE)

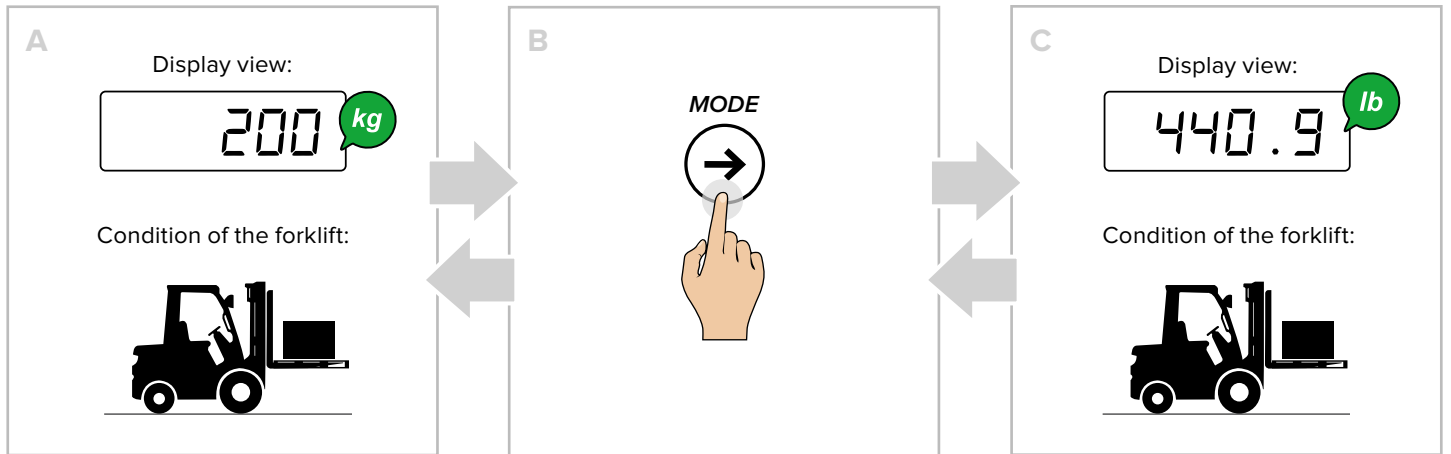

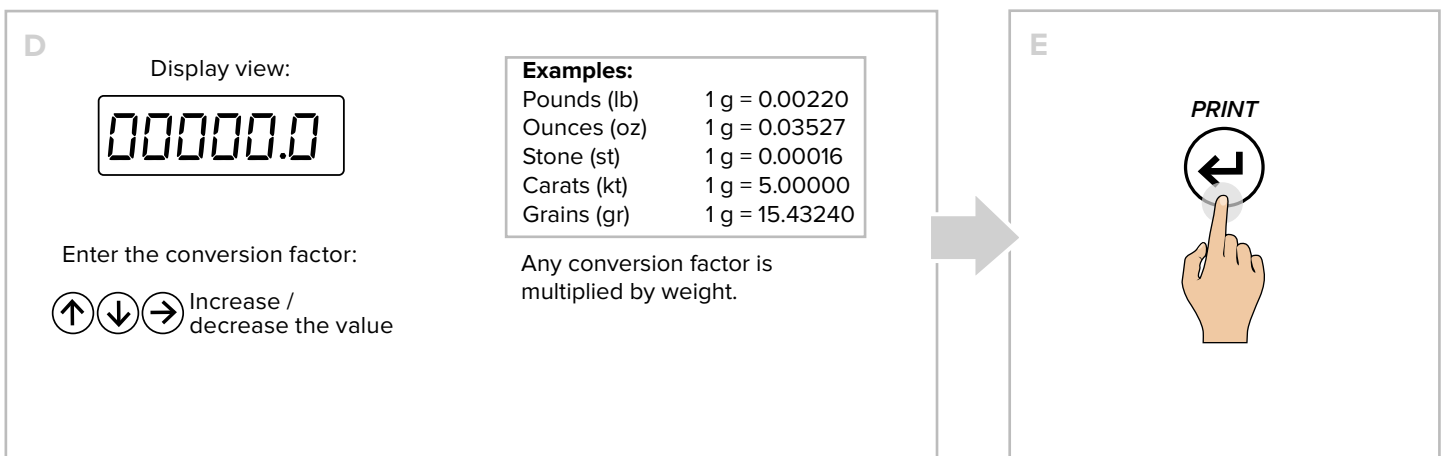
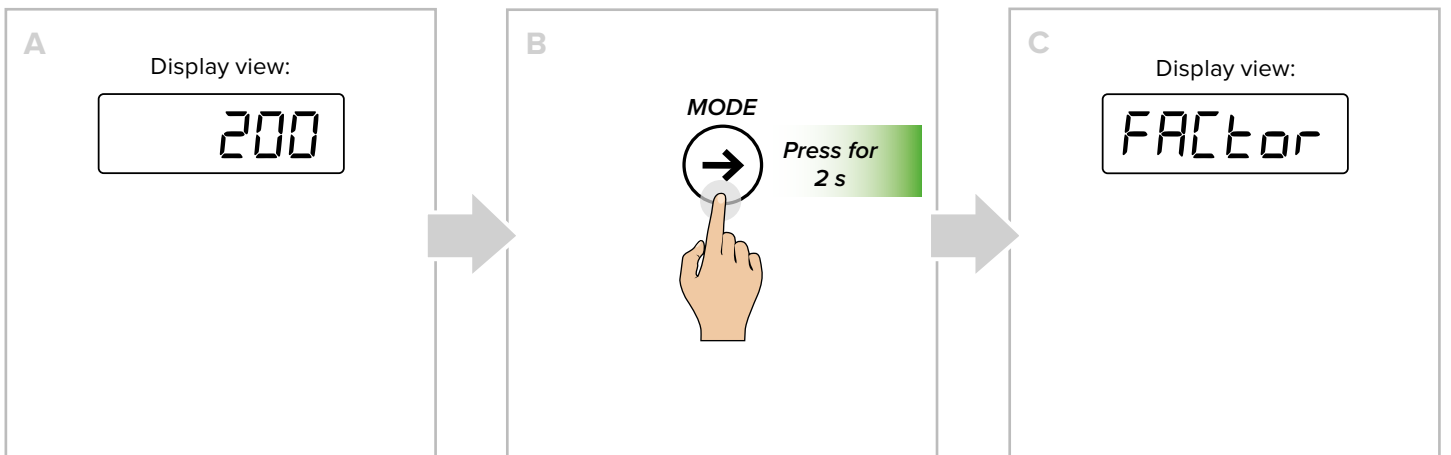

i By pressing at any time you can switch from weight in kg to weight in pounds.

HOW TO CONVERT THE UNIT OF MEASUREMENT WITH FREE CONVERSION FACTOR

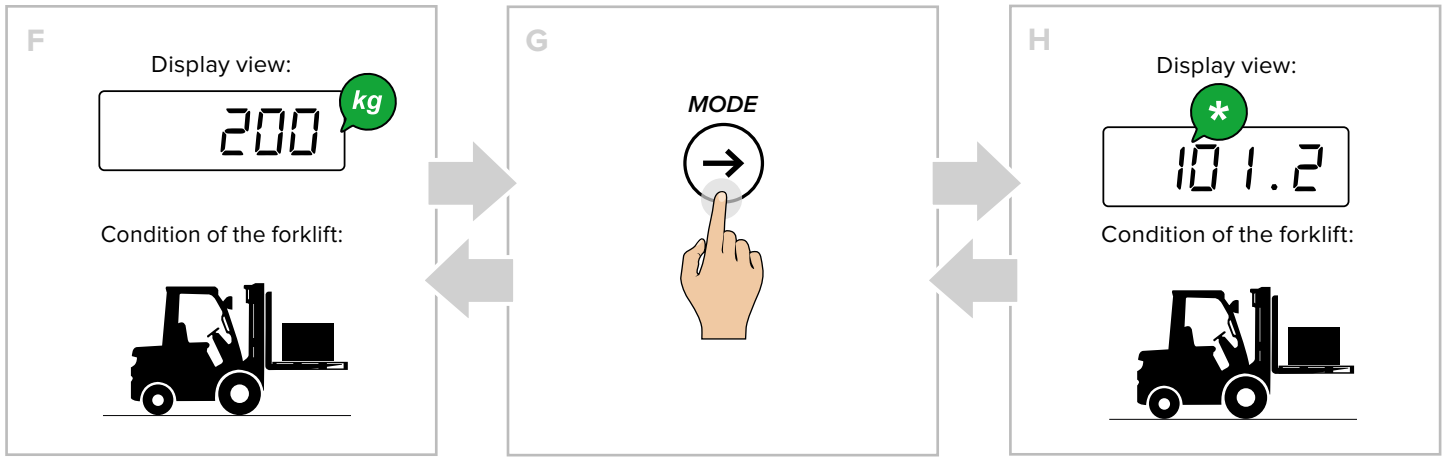

proceed →



i By pressing  at any time, the unit of measurement can be converted with a free conversion factor.

Replacing the printer roll

To replace the roll of the thermal printer (if applicable), proceed as follows:

- A. Open the door by pressing the centre key.
- B. Insert the roll with the thermal surface facing outwards.
- C. Close the door by pressing on both sides.
- D. Remove excess paper.

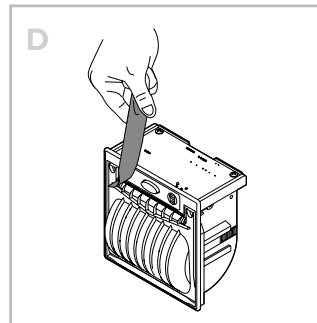
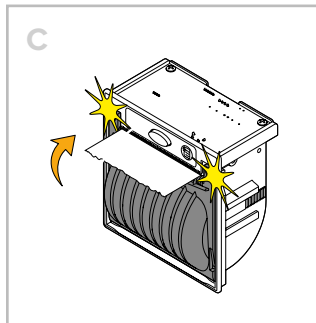
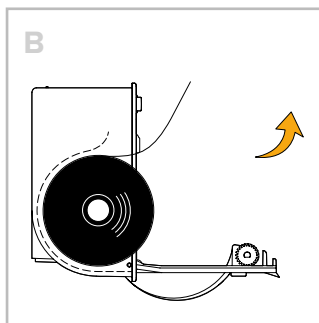
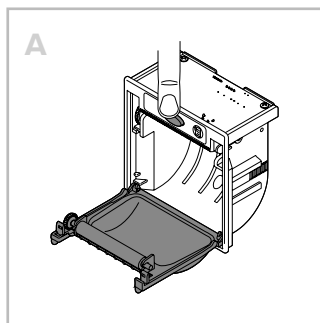



MENU

Enter
1. ⏪ 5 Sec.

Browse
↑ = ⏶
↓ = ⏷
→ = ⏩
← = ⏪

- A **CLoCF** →
- B **tLt.ShF** 1 **DAY**
- C **S.L.t.n** 2 **Month**
- D **d.S.t.n** 3 **YEAr**
- E **PrEC.10** 3 **hour**
- F **SCrEEEn** 3 **Minute**
- G **tArE**
- H **AutoFF**
- I **t.r.rES**
- J **rESEt**
- K **d.rG**

CLoCF - DATE AND TIME



Day

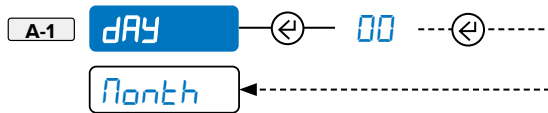

Month

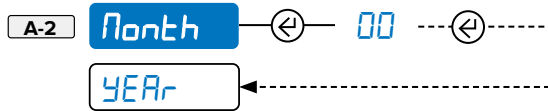

Year

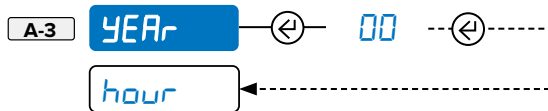

Hour

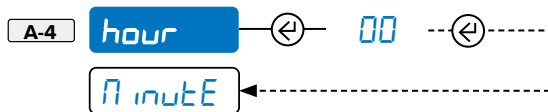

Minute

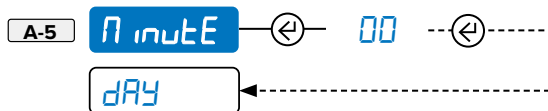

tLt.ShF - FORK SWITCH-ON SENSITIVITY



Enter the fork switch-on threshold value (from 0 to 255, default = 85).

A low value causes the forks to switch on more easily.

A high value causes more movement to be needed to switch them back on.

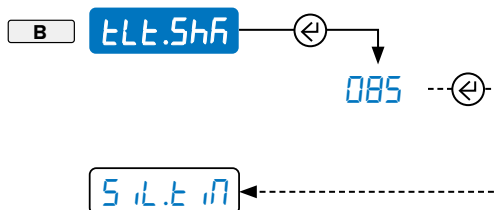



MENU

1. ⏪ 5 Sec.

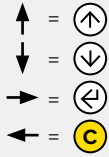

A CLoCR

B tLt.Shr

C S.L.t.n

D d.S.t.n

E Pr.EC.10

F SCrEEen

G tArE

H AutoFF

I t.n.rES

J rESEt

K d.nG

S.L.t.n - ENERGY SAVING ADJUSTMENT



Enter the idle time (in s) after which the forks switch to partial energy saving mode (see "Energy saving" chapter).

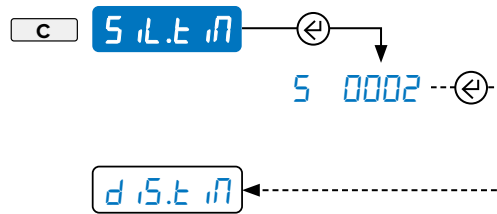

d.S.t.n - FORK AUTO SWITCH-OFF



Enter the idle time (in s) after which the forks automatically switch off. Move the forks to switch them back on.

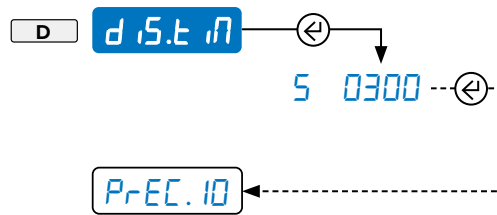

Pr.EC.10 - HIGH RESOLUTION READING DIVISION



This functions allows you to display the weight with ten times greater resolution.

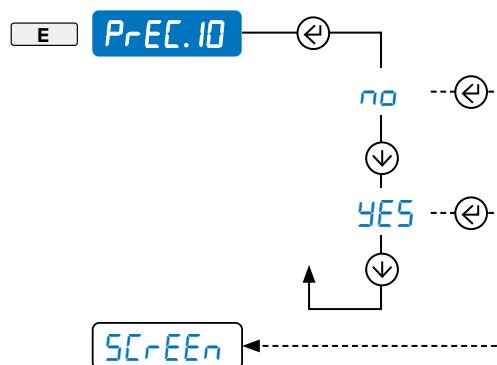



MENU

SCREEN - ADJUSTING THE DISPLAY



- Enter
1. (Enter) 5 Sec.
- Browse
- ↑ = (Up Arrow)
 - ↓ = (Down Arrow)
 - = (Left Arrow)
 - ← = (Right Arrow)

- A CLoCF
- B tLE.ShR
- C S.L.t.M
- D d.S.t.M
- E PrEC.10
- F SCREEN →
- G tArE 1 bAR.L it
- H AutoFF 2 br iGht
- I t.r.rES 3 LoCF
- J rESEt
- K d.rAG

Backlighting

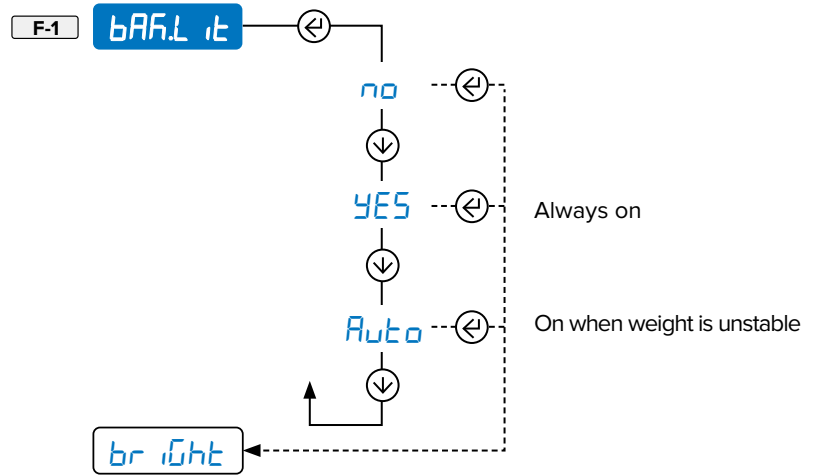

Brightness

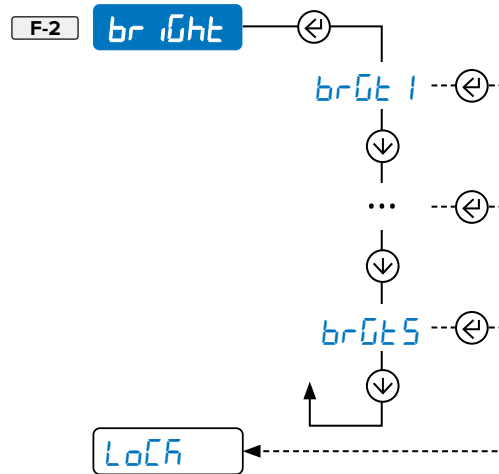

Display lock (for use by the manufacturer)

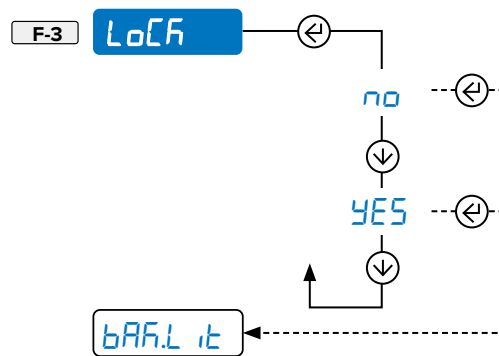



MENU

Enter

1. ⏪ 5 Sec.

Browse

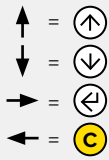

- A CLoCF
- B tLt.Shr
- C S.L.t.M
- D d.S.t.M
- E PrEC.10
- F SCrEEEn
- G tArE
- H AutoFF
- I t.r.rES
- J rESEt
- K d.rG

tArE - TARE

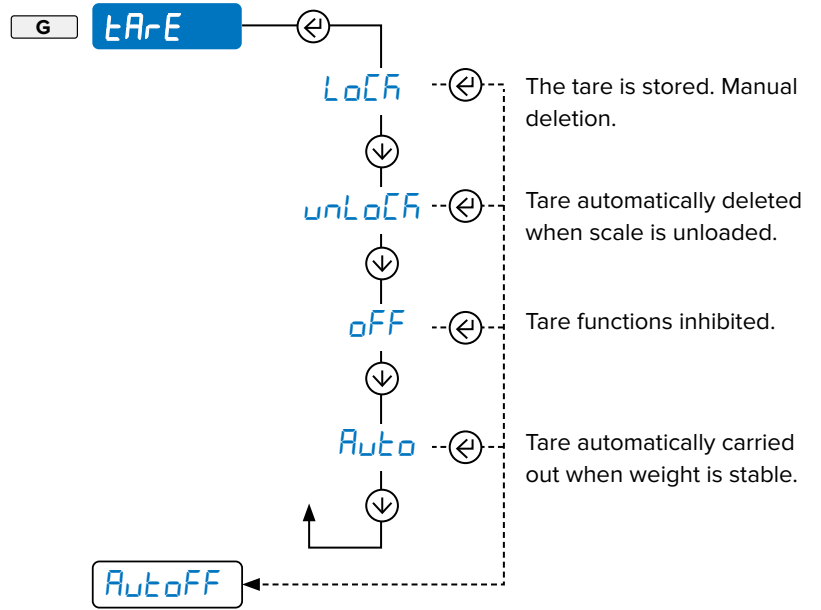

AutoFF - AUTOMATIC SWITCH-OFF

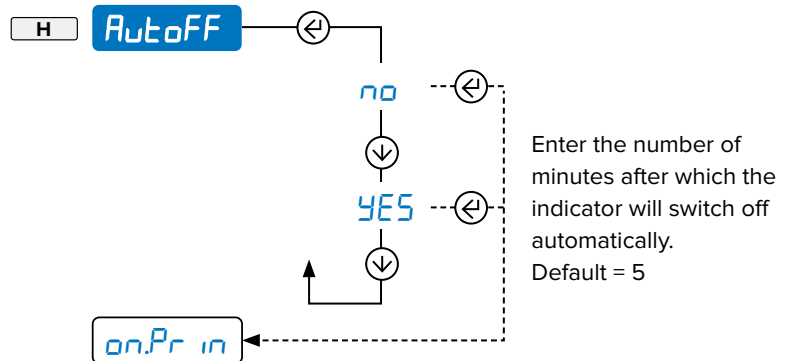

t.r.rES - TICKET NUMBER RESET

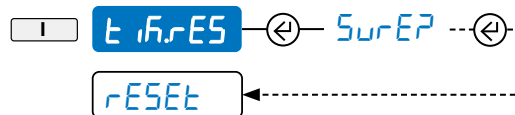



MENU

Enter

1. ⏪ 5 Sec.

Browse

- ↑ = ⏪
- ↓ = ⏩
- = ⏪
- ← = ⏩

A CLoCR

B tLt.Shr

C S.L.t.M

D d.S.t.M

E PrEC.10

F SCrEEen

G tArE

H AutoFF

I t.r.rES

J rESEt

K d.rAG

rESEt - FACTORY CONFIGURATION RESET

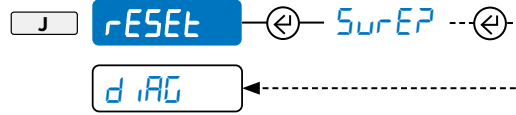

d.rAG - DIAGNOSTICS



K d.rAG ⏪ Reserved for technical staff.

MESSAGE	DESCRIPTION	SOLUTION
<i>BA .bt</i>	Waiting for Bluetooth connection	Check that the forks are switched on (battery inserted)
<i>BA .For</i>	Waiting for fork movement	Check that the forks are on (battery inserted) and perform a movement.
<i>tilt</i>	Tilt errors	Move the forks and bring them into a perfectly horizontal position. Move the forklift to a flat surface.
<i>busy</i>	Another printing operation is already in progress	Wait for the printing operation in progress to be finished and try again.
<i>unStAb</i>	The weight is unstable	If the supporting surface is affected by vibration from moving machinery or equipment, move the scale to another surface and try again.
<i>LoB</i>	The net or gross weight is negative or insufficient for printing	Add weight and try again.
<i>un.Over</i>	Underload o overload (____ or _____)	Restore a valid weight condition. If the problem persists, contact customer service.
<i>no.O.unS</i>	The scale was not unloaded after the last printing	Completely unload the scale, making sure the warning light •0• comes on. Reload the weight and try again.
<i>Err .Not</i>	The weight is unstable	Wait for stability (the warning light ~) and try again.

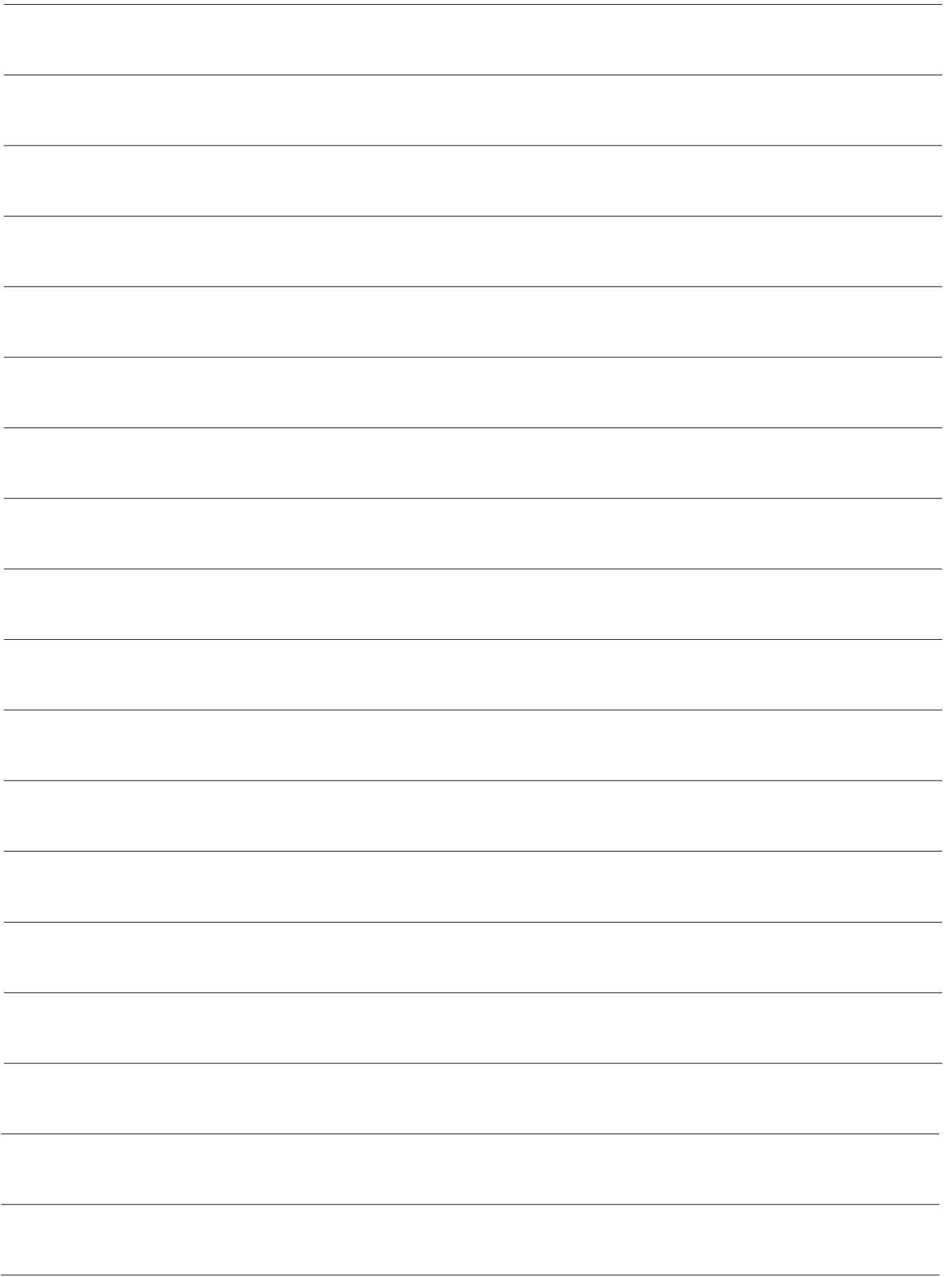

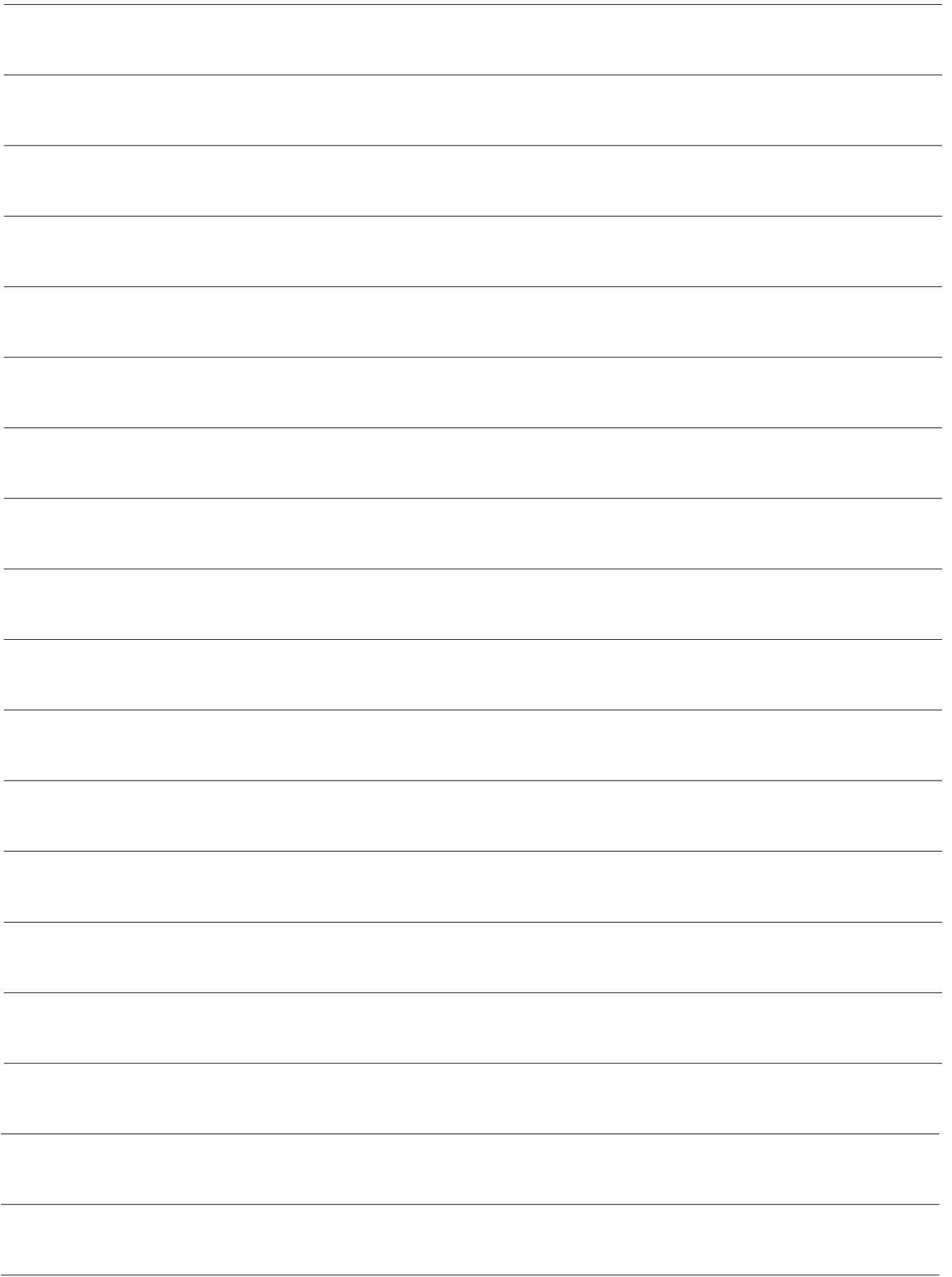



A RICE LAKE WEIGHING SYSTEMS COMPANY

HEAD OFFICE

Via Della Fisica, 20
41042 Spezzano di Fiorano, Modena - Italy
Tel. +39 0536 843418 - Fax +39 0536 843521

SERVICE ASSISTANCE

Via Dell'Elettronica, 15
41042 Spezzano di Fiorano, Modena - Italy
Tel. +39 0536 921784 - Fax +39 0536 926654

www.diniargeo.com

Stamp of the authorised service centre

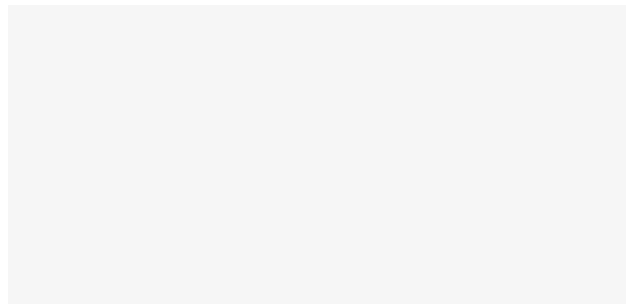

The information in this document is approximate and can be subject to variations without prior notice by Dini Argeo. In compliance with the norms in force, the official technical data are available in the updated version on the following website www.diniargeo.com or by contacting Dini Argeo Customer Service.

USER_MAN_ENG_TWINFORKS
Rev. 28.04.2021